



**TERAFEST**®

PRÉMIOVÉ PRODUKTY



**T E R A S Y**  
**P L O T Y | O B K L A D Y**

[WWW.WOODPLASTIC.CZ](http://WWW.WOODPLASTIC.CZ)



## FOREST



PREMIUM ↗ ↘ 137 x 22 mm ← s → 4 m ← A → 2-6 m  3,3 kg / bm  
 MAX ↙ ↚ 195 x 22 mm ← s → 4 m ← A → 2-4 m  4,6 kg / bm



## FOREST PLUS \*

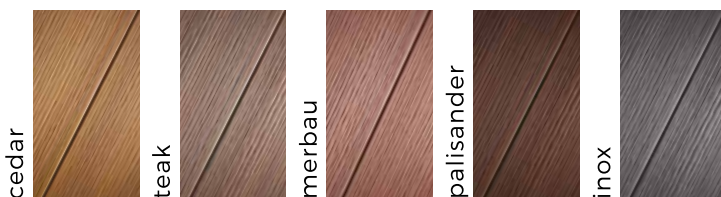



PREMIUM ↗ ↘ 137 x 22 mm ← s → 4 m ← A → 2-6 m  3,3 kg / bm

\* PLUS - varianta se žiháním

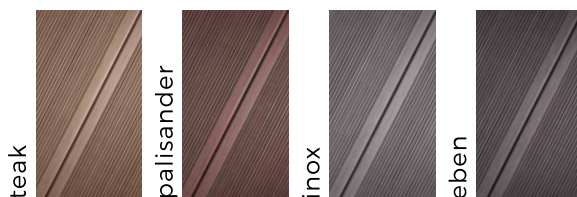

## STAR



PREMIUM ↗ ↘ 137 x 23 mm ← s → 4 m  3,4 kg / bm



## STYLE PLUS \*





PREMIUM ↗ ↘ 137 x 23 mm ← s → 4 m  3,5 kg / bm

\* PLUS - varianta se žiháním



## RUSTIC



TOP ↗ ↘ 140 x 22 mm ← s → 4 m ← A → 2-6 m  3,3 kg / bm  
 MAX ↙ ↚ 195 x 22 mm ← s → 4 m ← A → 2-4 m  4,6 kg / bm

# PLOTY / OBKLADY / LIŠTY



## PLOTOVKY 120 FOREST PLUS

PLOTOVKA 120

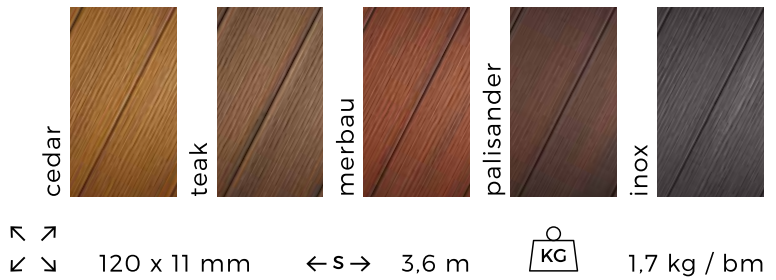

## OBKLADY FOREST ECO

ECO

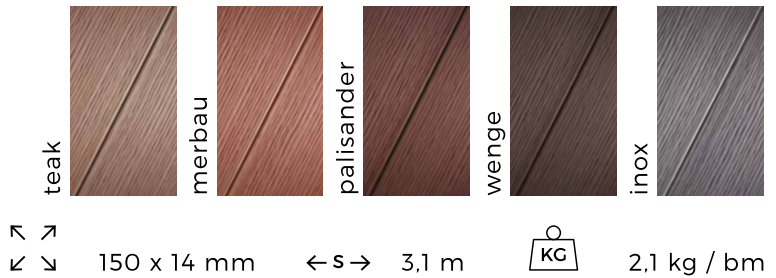

## LIŠTY

### HLADKÁ/ FOREST

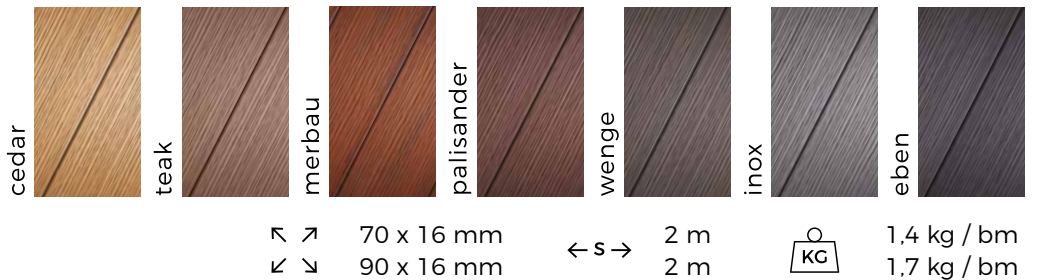

### FOREST/ RUSTIC

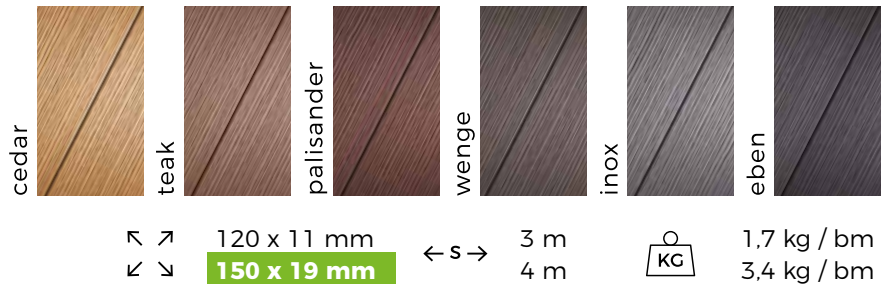

**NOVINKA**



# PROFILY / PŘÍSLUŠENSTVÍ

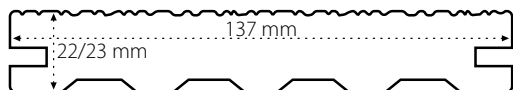

**PREMIUM** 

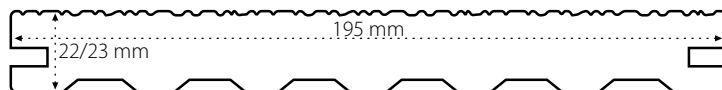

**MAX** 

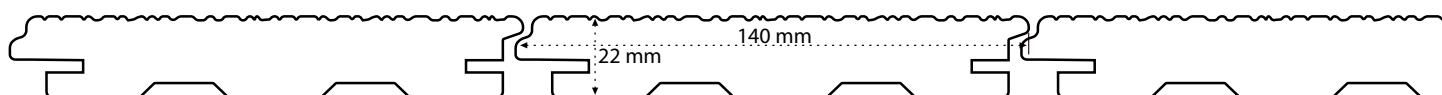

**TOP** 

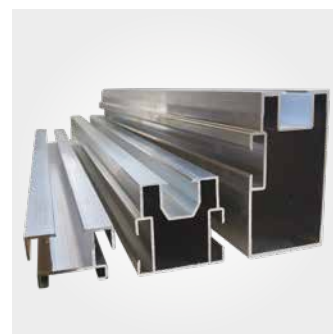
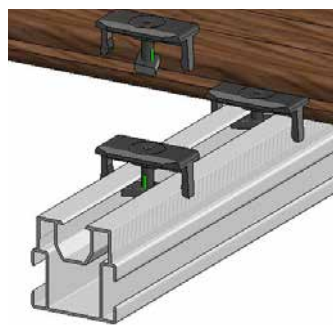

## KLIPY, VRUTY, NOSIČE

Pro snadné přichycení prken k nosičům využijte nerezové klipy a vruty. Na výběr jsou hliníkové SMART nebo WPC nosiče.

**Velký WPC nosič:** 50 x 50 x 3000/4000 mm, 2,3 kg/bm

**Malý WPC nosič:** 50 x 30 x 3000/4000 mm, 1,4 kg/bm

## SMART – KOTVÍCÍ HLINÍKOVÝ SYSTÉM

Systém nabízí vše potřebné pro rychlou montáž terasy: hliníkové nosiče, klipy a další spojovací materiál.

**Nosič 23:** 23 x 35 x 4000 mm, 0,39 kg/bm

**Nosič 40:** 40 x 42 x 4000 mm, 0,67 kg/bm

**Nosič 75:** 75 x 40 x 4000 mm, 1,10 kg/bm

## VYZRÁVÁNÍ BAREV

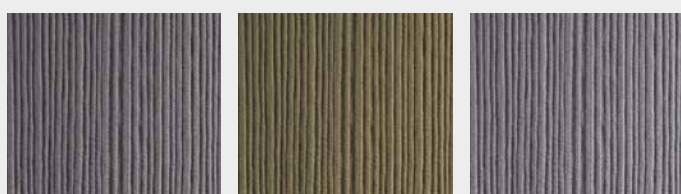
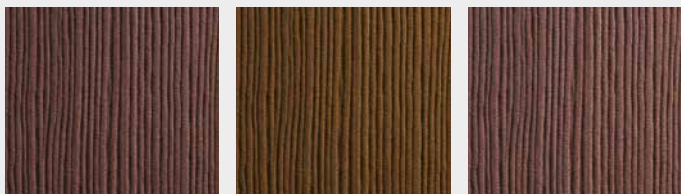

PO INSTALACI

PO 1 MĚSÍCI

PO 25 LETECH

## INFORMACE O MATERIÁLU

Materiál WoodPlastic® kombinuje ve správném poměru dřevo (60 %) a vysoce kvalitní, zdravotně nezávadný polymer HDPE (40 %). Materiál je odolný vůči povětrnostním vlivům, chlorované i slané vodě a díky vysoké UV odolnosti je stálobarevný.



**VYROBENO V ČR**  
Produkty WoodPlastic®  
vyrábíme v České republice  
na základě americké licence  
Strandex.



**ZÁRUKA AŽ 25 LET**  
Svým produktům věříme,  
proto poskytujeme záruku  
v délce až 25 let. Životnost teras  
však laboratorní testy odhadují na  
mnohem delší dobu.



**BEZPEČNOST  
– BEZ TRÍSEK**  
Terasy WoodPlastic® mají  
protiskluzový povrch a na rozdíl  
od dřeva nikdy netvoří třísky.



**SNADNÝ ÚKLID  
– ŽÁDNÉ NATÍRÁNÍ**  
Terasy WoodPlastic®  
se nenatírají, neolejují ani  
jinak povrchově neošetřují.



# 7 DŮVODŮ, PROČ ZVOLIT PRKNA TERAFEST

MINIMÁLNÍ POTŘEBA ÚDRŽBY ŠETŘÍ ČAS I PENÍZE. TERASY NENÍ TŘEBA NATÍRAT, OLEJOVAT ANI IMPREGNOVAT.

ČESKÝ PRODUKT VYRÁBĚNÝ PODLE AMERICKÉ LICENCE. OVĚŘENÝ MATERIÁL, NA TRHU DÉLE NEŽ 30 LET.

EKOLOGICKÝ, 100 % RECYKLOVATELNÝ A ZDRAVOTNĚ NEZÁVADNÝ VÝROBEK S PEFC CERTIFIKACÍ.

PRKNA MAJÍ PLNÝ PROFIL, JSOU PROBARVENÁ A STÁLOBAREVNÁ. JEJICH KVALITA SE ČASEM NEMĚNÍ.

BEZPEČNOST ZAJIŠŤUJE PROTISKLUZOVÝ POVRCH BEZ TRÍSEK A ŠTĚPŮ, VČETNĚ SKRYTÉHO KOTVENÍ.

VÝROBKY ODOLÁVAJÍ DEŠTI, SNĚHU, MRAZU I UV ZÁŘENÍ. MATERIÁL JE ODOLNÝ VŮČI BAZÉNOVÉ CHEMII I SLANÉ VODĚ.

NABÍDKA ZAHRNUJE ŠIROKÉ SPEKTRUM BAREVNÝCH ODTÍNŮ, POVRCHY JSOU ATRAKTIVNÍ A PŘÍJEMNÉ NA DOTYK.

KDE KOUPIT

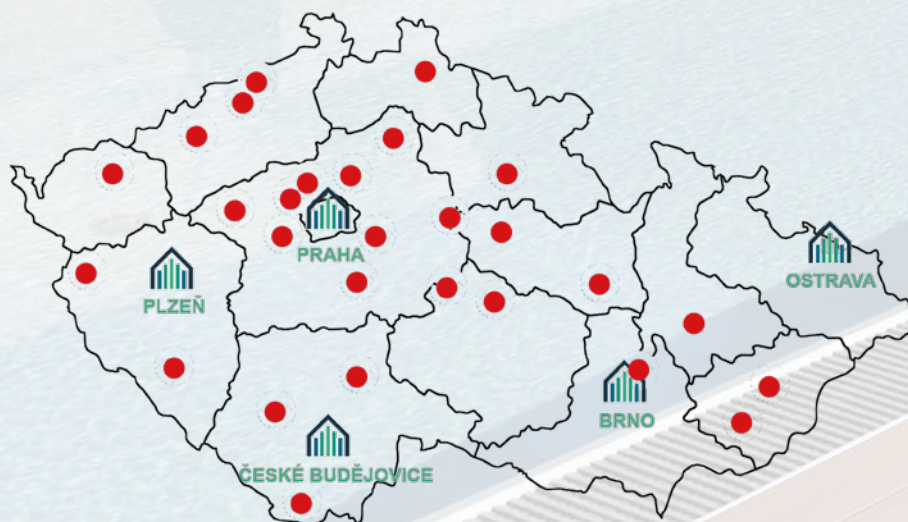

**WOODPLASTIC®**  
ČESKÝ VÝROBCE PRODUKTŮ WPC

**WPC - WOODPLASTIC a.s.**

BUKOVANY 181 | 257 41 TÝNEC NAD SÁZAVOU | ČESKÁ REPUBLIKA  
+420 321 001 523 | [WPC@WOODPLASTIC.CZ](mailto:WPC@WOODPLASTIC.CZ) | [WWW.WOODPLASTIC.CZ](http://WWW.WOODPLASTIC.CZ)