



**TERAFEST**®

PREMIUM PRODUCTS

**DECKING**

**FENCES | CLADDING**

[WWW.WOODPLASTIC.EU](http://WWW.WOODPLASTIC.EU)



**FOREST**



cedar



teak

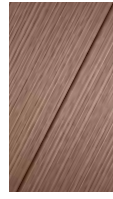

palisander

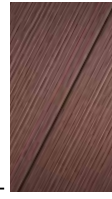

wenge



inox



eben



PREMIUM  
MAX



137 x 22 mm  
195 x 22 mm



4 m  
4 m



2-6 m  
2-4 m



3,3 kg / 1m  
4,6 kg / 1m



**FOREST PLUS\***



cedar



teak

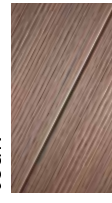

merbau

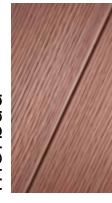

palisander

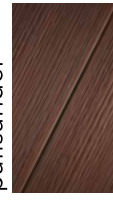

inox

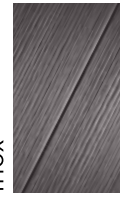

PREMIUM



137 x 22 mm



4 m



2-6 m



3,3 kg / 1m

\*PLUS - extra brindle finish



**STAR**



teak



palisander



inox

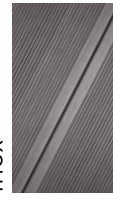

eben



PREMIUM



137 x 23 mm



4 m



3,4 kg / 1m



**STYLE PLUS\***



teak



palisander



inox



PREMIUM



137 x 23 mm



4 m



3,5 kg / 1m

\*PLUS - extra brindle finish



**RUSTIC**



teak

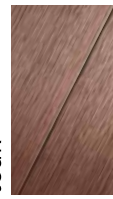

palisander

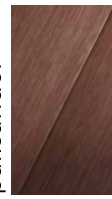

wenge

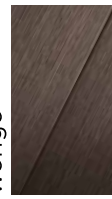

inox

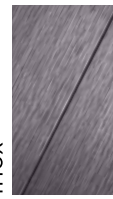

eben



TOP  
MAX



140 x 22 mm  
195 x 22 mm



4 m  
4 m



2-6 m  
2-4 m



3,3 kg / 1m  
4,6 kg / 1m

# FENCES / CLADDING / BOARDS



## FENCE 120 FOREST PLUS

FENCE 120

cedar

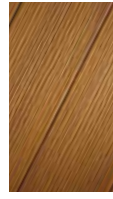

teak

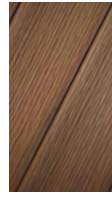

merbau

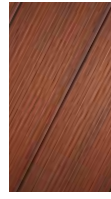

palisander

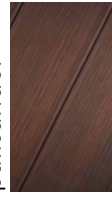

inox



120 x 11 mm

← s → 3,6 m



1,7 kg / lm



## ECO CLADDING FOREST

ECO

teak

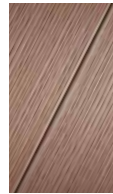

merbau

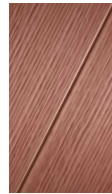

palisander

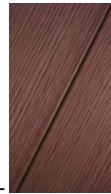

wenge



inox



150 x 14 mm

← s → 3,1 m



2,1 kg / lm

## BOARDS SMOOTH/ FOREST

cedar



teak

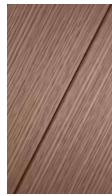

merbau

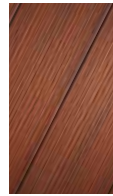

palisander

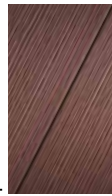

wenge

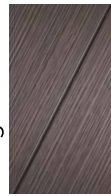

inox

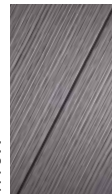

eben



70 x 16 mm  
90 x 16 mm

← s → 2 m  
2 m



1,4 kg / lm  
1,7 kg / lm

## FOREST/ RUSTIC

cedar



teak

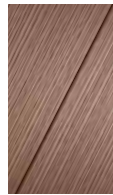

palisander

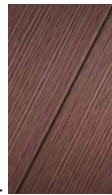

wenge

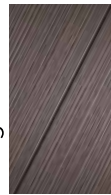

inox



eben



120 x 11 mm  
150 x 19 mm

← s → 3 m  
4 m



1,7 kg / lm  
3,4 kg / lm

NEW



# PROFILES / ACCESSORIES

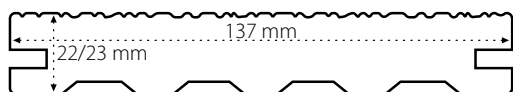

**PREMIUM** 

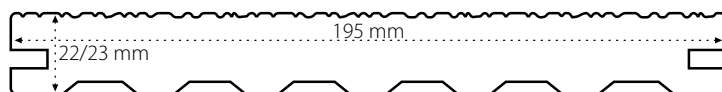

**MAX** 

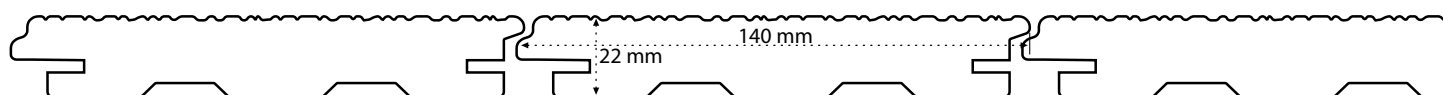

**TOP** 

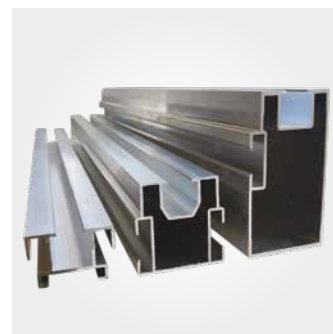
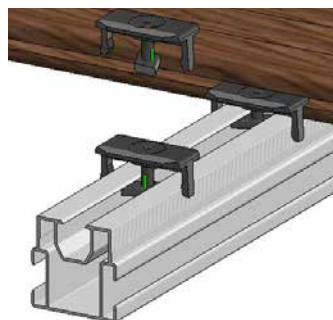

## CLIPS, SCREWS and JOISTS

Stainless steel clips and screws are used to easily fix the boards to the joists. You can choose either aluminum SMART or WPC joists.

**Large joist:** 50 x 50 x 3000/4000 mm, 2,3 kg/lm

**Small joist:** 50 x 30 x 3000/4000 mm, 1,4 kg/lm

## SMART –ALUMINIUM FIXING SYSTEM

The SMART system offers all the necessary components to assembly your decking – joists, clips and other fastening material.

**Joist 23:** 23 x 35 x 4000 mm, 0,39 kg/lm

**Joist 40:** 40 x 42 x 4000 mm, 0,67 kg/lm

**Joist 75:** 75 x 40 x 4000 mm, 1,10 kg/lm

## COLOR AGING



AFTER  
INSTALLATION

1 MONTH

25 YEARS

## INFORMATION ABOUT THE MATERIAL

WoodPlastic® material combines wood (60%) and a high quality, non toxic HDPE polymer (40%) at just the right ratio. The material is highly resistant toward rain, snow, frost, UV, salt and chlorinated water.



**MANUFACTURED IN EUROPEAN UNION**

WoodPlastic® products are made in the European Union.

**UP TO 25 YEARS WARRANTY**

We trust in our Woodplastic® products. That's why we provide a warranty lasting up to 25 years.

**ANTI-SLIP SURFACE**

WoodPlastic® decking has an anti-slip surface, and unlike wood, it never splinters.

**NO PAINTING**

WoodPlastic® decking requires no waxing or oil coating.



# **7 REASONS WHY YOU SHOULD CHOOSE DECKING TERAFEST®**

**YOU SAVE BOTH TIME AND MONEY THANKS TO THE DECKING'S LOW MAINTENANCE REQUIREMENTS. IT REQUIRES NO WAXING OR OIL COATING.**

**MADE IN THE EUROPEAN UNION.**

**ENVIRONMENTALLY FRIENDLY, 100% RECYCLABLE MATERIAL, PEFC - ENVIRONMENTAL CERTIFICATION.**

**THE DECKING HAS A SOLID PROFILE WITH COLOR COVERING THE ENTIRE SURFACE. THE DECKING IS ALSO COLOR RESISTANT MEANING ITS QUALITY WON'T CHANGE OVER TIME.**

**SAFETY IS GUARANTEED BY THE DECKING'S ANTI-SLIP SURFACE, WHICH NEVER SPLINTERS. A SAFE, HIDDEN FASTENING SYSTEM IS ALSO INCLUDED.**

**THE PRODUCT IS RESISTANT TOWARD RAIN, SNOW, FROST, UV, SALT AND CHLORINATED WATER.**

**ITS SURFACE IS ATTRACTIVE AND PLEASANT TO THE TOUCH.**

**WPC - WOODPLASTIC a.s.**

**BUKOVANY 181 | 257 41 TÝNEC NAD SÁZAVOU | CZECH REPUBLIC  
+420 321 001 523 | [WPC@WOODPLASTIC.EU](mailto:WPC@WOODPLASTIC.EU) | [WWW.WOODPLASTIC.EU](http://WWW.WOODPLASTIC.EU)**